

MANUAL CU INSTRUCȚIUNI DE UTILIZARE

 SAUNA

MODEL:FS-153JX

ATENȚIE:

1. Va rugam sa consultati acest manual inaintea montajului si inaintea utilizarii saunei.
2. Va recomandam sa folositi un izolant de buna calitate si impamantare.
3. Va rugam sa instalati un comutator general pentru alimentarea electrica in conformitate cu legile in vigoare.
4. Utilizatorii hipertensivi sau cei in stare de ebrietate ar trebui sa nu foloseasca acest produs.
5. Copiii trebuie sa fie sub supravegherea unui adult de fiecare data cand intrebuinteaza sauna.
6. Nu folositi lichide corozive in cadrul cabinei.
7. Nu folositi sauna pentru o perioada foarte foarte lunga de timp. Teava se poate incalzi in mod excesiv dupa o astfel de intrebuintare prelungita.
8. Compania noastra nu-si asuma nicio responsabilitate in cazul folosirii incorecte a saunei.
9. Cand doriti sa aruncati produsul la gunoi, va rugam sa folositi recipientele adecvate in conformitate cu legea din tara dvs.

PARAMETRI TEHNICI

1. Voltaj nominal : AC**220V ± 10%** **50Hz/60Hz**
2. Puterea incalzitorului : 3000W
3. 1500X1500X1900mm



FUNCTIONARE

(1) Alimentare electrica

Apasa:  pentru pornirea sistemului. Gradele care sunt afisate indica temperatura din cabina. Durata afisata este de 80 minute. Apasa din nou pe aceeași tasta pentru a inchide toate functiile.

(2) Functia de sauna

1. Porneste functia de sauna apasand pe tasta :  si apoi pe ecran va aparea valoarea temperaturii (cifrele vor palpai). Pentru inchiderea acestei functii, apasa același buton.

2. Apasa pe:  pt. alegerea temperaturii, apasa pe tastele:  sau: 

Temperatura implicita este de 45°C, putand alege între 25°C-75°C.

Atunci cand temperatura afisata pe ecran ajunge la temperatura presetata de catre utilizator, incalzitorul saunei se va opri din functionare.



3. Apasa pe:  pt. alegerea duratei saunei si apoi se apasa pe:  si pe: 



Durata implicita este de 80 minute, se poate alege între 1min- 99 min.

Atunci cand durata afisata pe ecran ajunge la temperatura presetata, incalzitorul isi opreste functionarea.

(3) FM/CD : Se porneste sistemul si se apasa:  pentru pornirea

radio-ului si pe:  pt. reglarea posturilor (in sus si in jos).

Apasa:  pt. ajustarea volumului la radio, prin tastele:  si: 

Se apasa pe :  pt. a porni CD playerul, apoi se regleaza volumul cu: 

si apoi sunt folosite una dintre tastele:  sau:  in sus si in jos. Apasand tasta: 

o a treia oara, se vor opri toate functiile sistemului radio.

(4) Ozonizorul

La inchiderea sistemului, ozonizorul porneste in mod automat.

(4) Lumina de deasupra

Apasa:  pentru pornirea luminii si inca o data pentru oprirea ei.

SCHITA

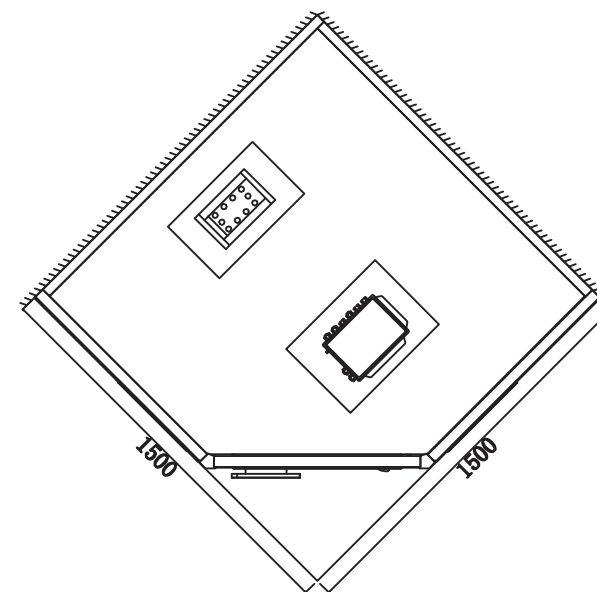
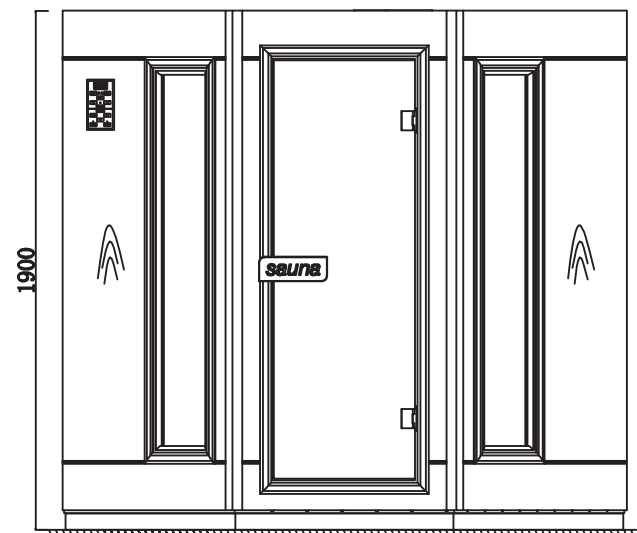

1500X1500X1900mm

PARTI COMPONENTE

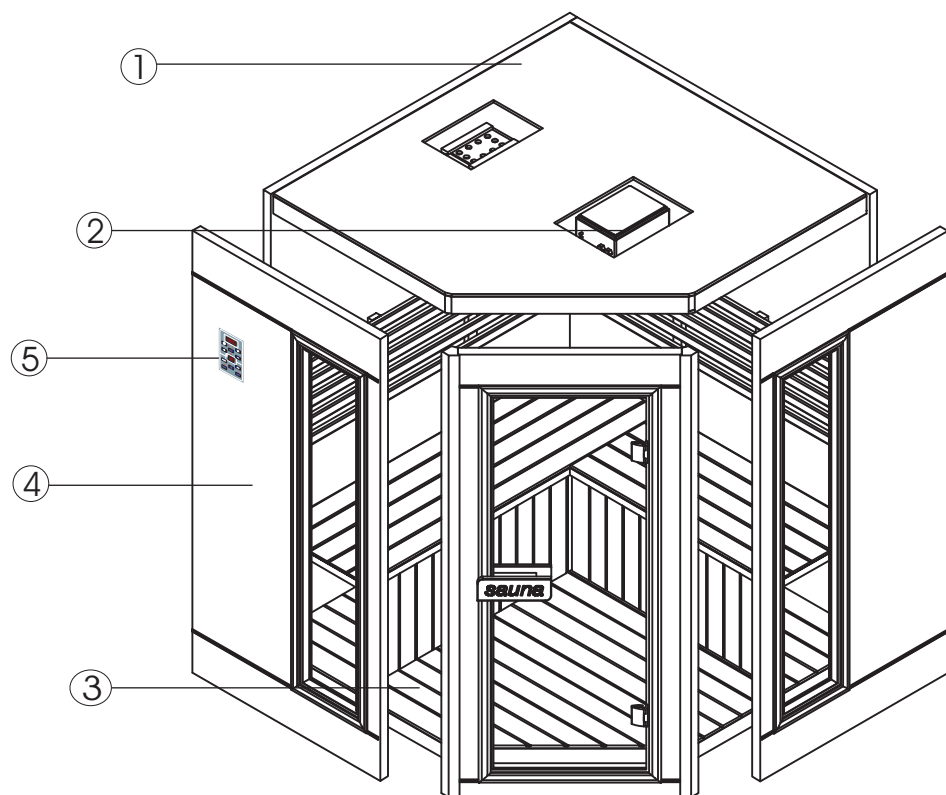

1. TAVAN
2. CUTIE ELECTRICA
3. INCALZITORUL SAUNEI
4. CORPUL CABINEI
5. PANOUL DE CONTROL

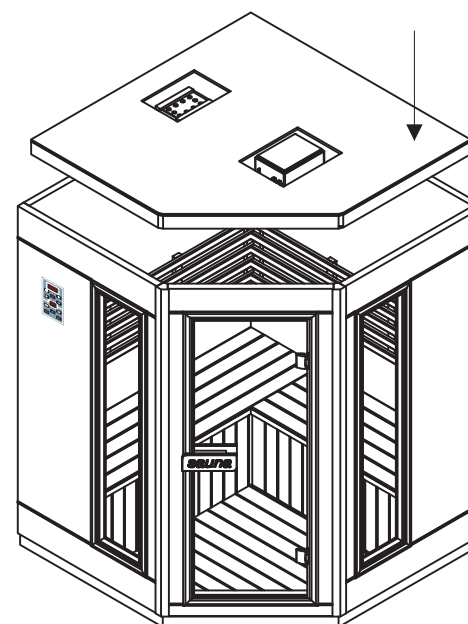

5. MONTATI TAVANUL

D5

6. TERMINAREA MONTAJULUI

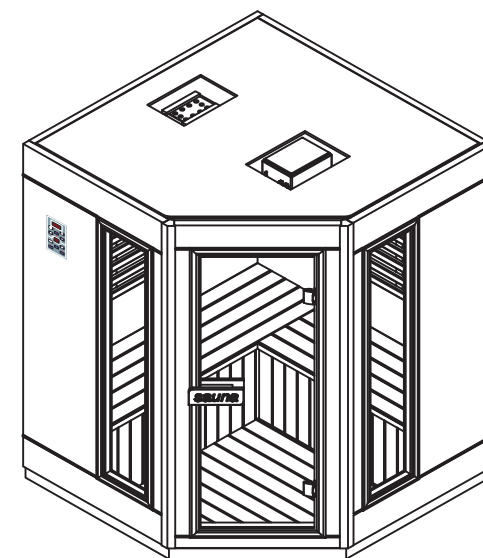

D6

CONEXIUNI LA INSTALARE

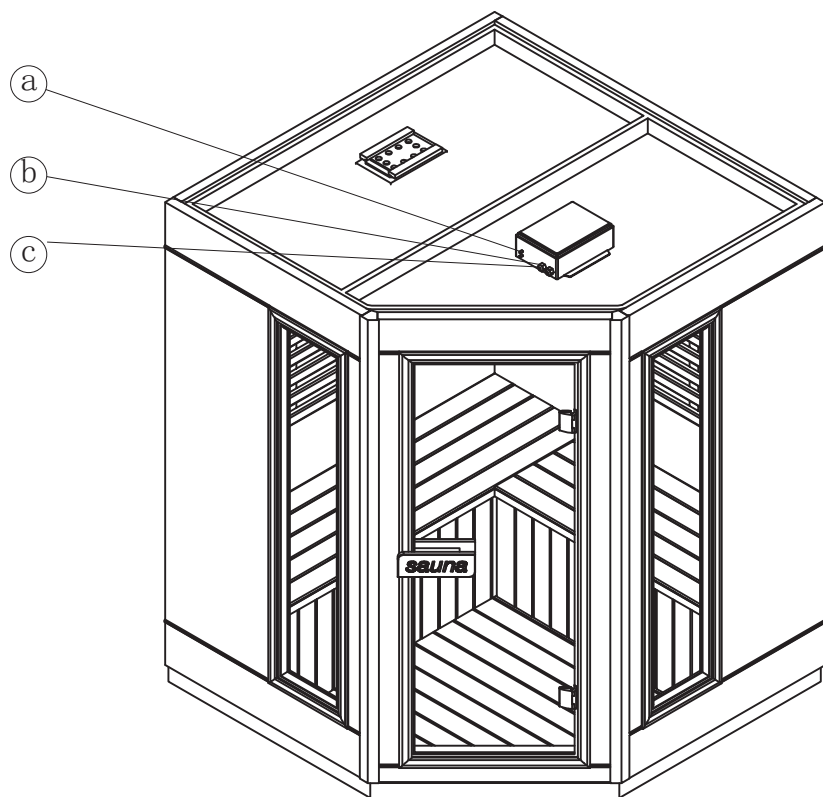

- A. Conexiuni electrice
- B. Incalzitorul saunei
- C. Panoul de control

DIAGRAMA INSTALARII

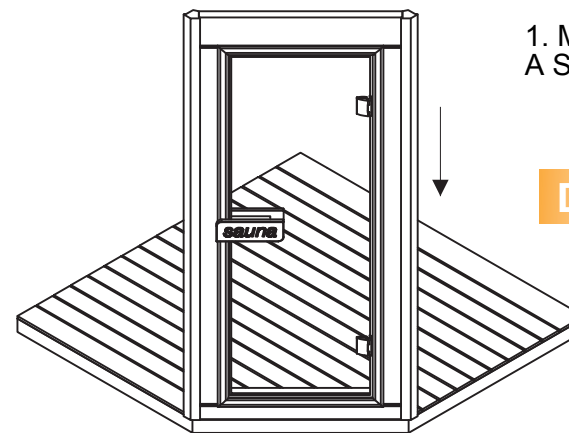

1. MONTATI PARTEA DIN FATA
A SAUNEI PE BAZA

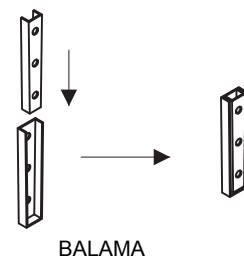

2. MONTATI AMBELE PARTI
LATERALE PE BAZA

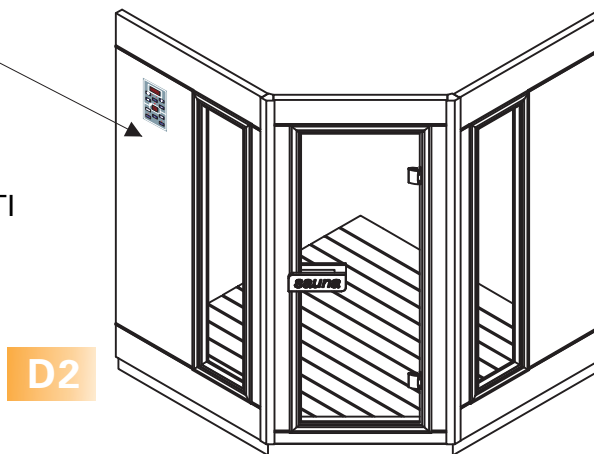



BALAMA

3. MONTATI PLACA DIN SPATE

D3

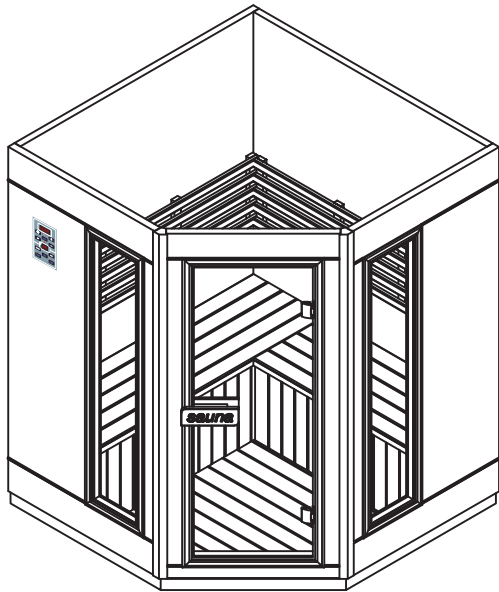
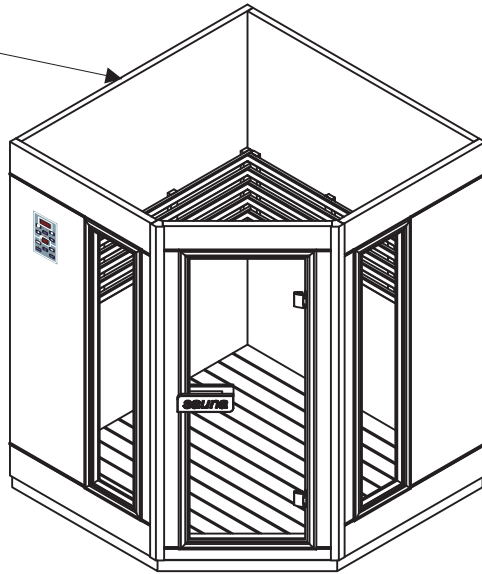

4. MONTATI BANCUTA IN INTERIORUL SAUNEI

D4

CIRCUIT

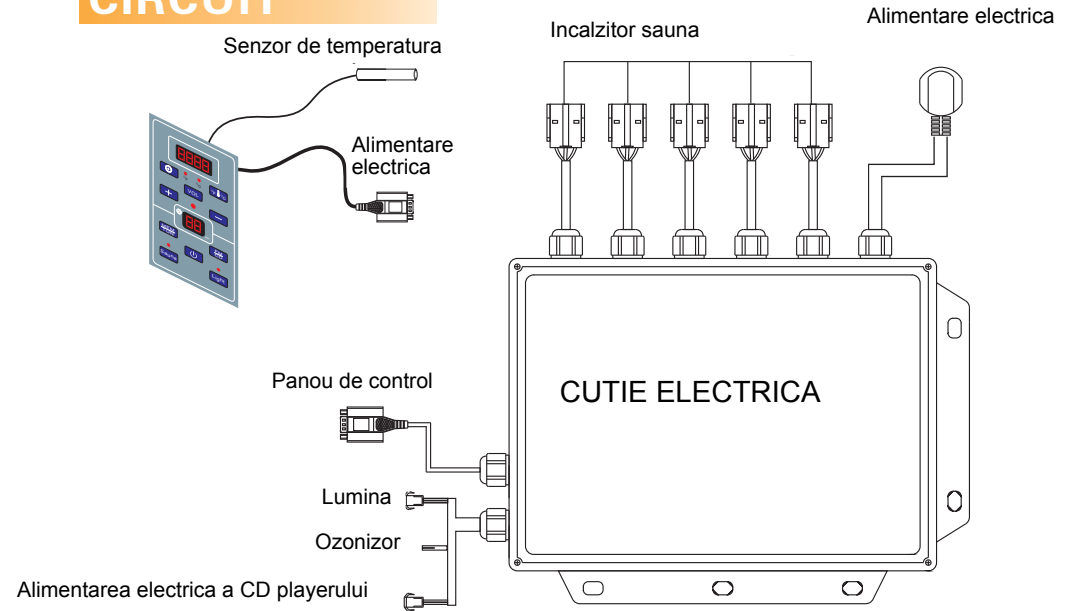

PANOU DE CONTROL

